



Grillo

AGRIGARDEN MACHINES



GZ

120-123-220-223



GZ 120



GZ 223

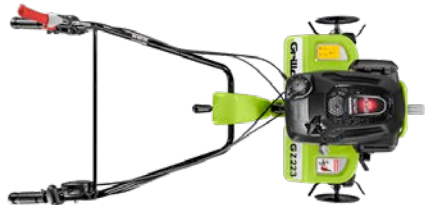

GZ 223



GZ 123



GZ 220

		HP-kW	CC	 L (US qts)						 kg (lb)
GZ 120	RVM120 RATO	HP 2.7 - kW 2	120/1	0,8 (0.84)		155 rpm	--	A 28 cm (11 in)	52 cm (20 in)	35 (77)
GZ 123	GCV 170 Honda	HP 4.8 - kW 3.6	166/1	0,9 (0.95)		155 rpm	--	A 28 cm (11 in)	75 cm (29.5 in)	39 (86)
GZ 220	RVM120 RATO	HP 2.7 - kW 2	120/1	0,8 (0.84)		155 rpm	Max 2,1 km/h (1.3 mph)	A 28 cm (11 in)	52 cm (20 in)	41 (90)
GZ 223	GCV 170 Honda	HP 4.8 - kW 3.6	166/1	0,9 (0.95)		155 rpm	Max 2,1 km/h (1.3 mph)	A 28 cm (11 in)	75 cm (29.5 in)	45 (99)

PRINCESS

M1 - MR









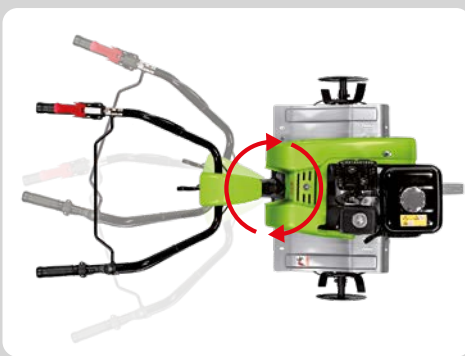



PRINCESS MR



PRINCESS M1



		HP-kW	CC	 L (US qts)						 kg (lb)
M1	G 200 FA Loncin	HP 5.5 - kW 4.1	196/1	3 (3.2)		① 132 rpm	--	A 32 cm (12 in)	30-52-77 cm (12-20-30 in)	62 (137)
MR	G 200 FA Loncin	HP 5.5 - kW 4.1	196/1	3 (3.2)		① 132 rpm	Max 2,3 km/h (1.4 mph)	A 32 cm (12 in)	30-52-77 cm (12-20-30 in)	64 (141)
	GX 200 Honda	HP 5.5 - kW 4.1	196/1	3,1 (3.3)						62 (137)

PRINCESS

MP3 - MP3 PRO



PRINCESS MP3



PRINCESS MP3 PRO

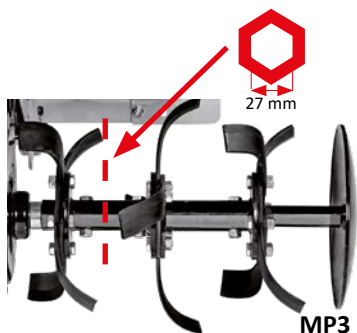

MP3 PRO



MP3



MP3 LABOUR KIT

		HP-kW	CC	 L (US qts)						 kg (lb)
MP3	G 200 FA Loncin	HP 5.5 - kW 4.1	196/1	3 (3.2)		ⓘ 36 rpm Ⓜ 160 rpm	Max 2,3 km/h (1.4 mph)	A 32 cm (12 in)	30-52-77 cm (12-20-30 in)	65 (143)
MP3 PRO	G 200 FA Loncin	HP 5.5 - kW 4.1	196/1	3 (3.2)		ⓘ 36 rpm Ⓜ 160 rpm	Max 2,3 km/h (1.4 mph)	A 32 cm (13 in)	56-82 cm (22-32 in)	68 (150)
	GX 200 Honda	HP 5.5 - kW 4.1	196/1	3,1 (3.3)		ⓘ 36 rpm Ⓜ 160 rpm	Max 2,3 km/h (1.4 mph)	A 32 cm (13 in)	56-82 cm (22-32 in)	66 (145)

HR7 PRO



HR78 PRO



HR78 PRO

















HR76 PRO



HR75 PRO



		HP-kW	CC/ 	 L (US qts)						 kg (lb)
HR75 PRO	G 200 FA Loncin	HP 5.5 - kW 4.1	196/1	 3 (3.2)		① 53 rpm ② 123 rpm ③ 162 rpm	Max 3 km/h (1.8 mph)	A 32 cm (12 in)	58-85-111 cm (23-33-43 in)	83 (183)
HR76 PRO	G 300 FA Loncin	HP 9.3 - kW 6.8	302/1	 6,1 (5.6)						95 (209.4)
HR77 PRO	SH178 FA Norwik	HP 5.3 - kW 4	306/1	Diesel  3,5 (3.6)						97 (213.8)
HR78 PRO	SH178 FA Norwik	HP 5.3 - kW 4	306/1	Diesel  3,5 (3.6)						105 (231.4)

11500

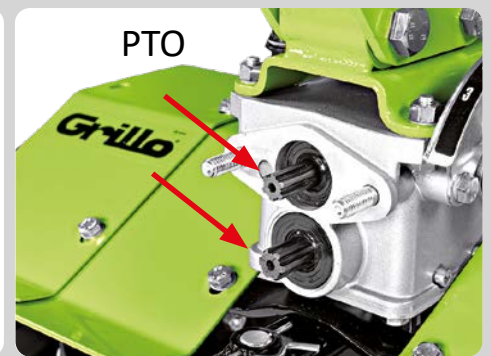
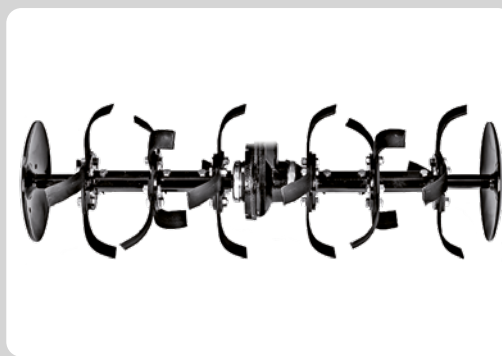

		HP-kW	CC/	 L (US qts)						 kg (lb)
11500	GX 200 Honda	HP 5.5 - kW 4.1	196/1	3,1 (3.3)						82 (180.7)
	GX 270 Honda	HP 8.4 - kW 6.3	270/1	5,3 (5.6)		① 53 rpm ② 123 rpm ③ 162 rpm	Max 3 km/h (1.8 mph)	A 34 cm (13.4 in)	59-86-112 cm (23-34-44 in)	90 (198.4) 98 (216)
	KD15 350 Kohler	HP 7.5 - kW 5.5	349/1	Diesel 4,3 (4.5)						121 (266.7)

G 45

COUNTER-ROTATING TILLER



		HP-kW	CC/	 L (US qts)						
G 45	G 200 FA Loncin	HP 5.5 - kW 4.1	196/1	3 (3.2)		 4.00-8 1,6 km/h (1 mph) →	 4.00-8 2,5 km/h (1.5 mph) ←	 A 26 cm (10 in)	50 cm (20 in)	82 (181)

G 46















COUNTER-ROTATING TILLER



		HP-kW	CC	L (US qts)						kg (lb)
G 46	GX 200 Honda	HP 5.5 - kW 4.1	196/1	3,1 (3.3)		4.00-8 1,6 km/h (1 mph) →	4.00-8 1,6 km/h (1 mph) ←	A 26 cm (10 in)	50 cm (20 in)	98 (216)

G 52



										
G 52	G 200 FA Loncin	HP 5.5 - kW 4.1	196/1	3 (3.2)		 13x5.00-6 1,4 km/h (0.9 mph) → 2,2 km/h (1.4 mph) ←	 13x5.00-6 2,2 km/h (1.4 mph) → 1,4 km/h (0.9 mph) ←	 A 26 cm (10 in)	37-50 cm (15-20 in)	67 (148)

G 55



		HP-kW	CC	 L (US qts)						 kg (lb)
G 55	G 200 FA Loncin	HP 5.5 - kW 4.1	196/1	 3 (3.2)		 4.00-8	 4.00-8	 A 26 cm (10 in)	 58 cm (23 in)	89 (196)
	GX 200 Honda	HP 5.5 - kW 4.1	196/1	 3,1 (3.3)		 4.00-8 I 1,1 km/h (0.7 mph) II 2,6 km/h (1.6 mph) I 1,1 km/h (0.7 mph) II 2,6 km/h (1.6 mph)	 4.00-8 I 1,1 km/h (0.7 mph) II 2,6 km/h (1.6 mph)			87 (192)

G 84



FORWARD AND COUNTER-ROTATING TILLER

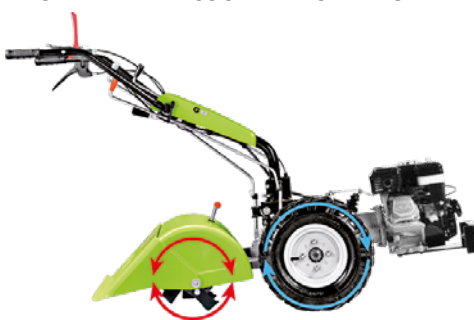

		HP-kW	CC	 L (US qts)						 kg (lb)
G 84	GX 200 Honda	HP 5.5 - kW 4.1	196/1	3,1 (3.3)		 4.00-8 I 1,1 km/h (0.7 mph) II 2,6 km/h (1.6 mph) →	 4.00-8 I 1,1 km/h (0.7 mph) II 2,6 km/h (1.6 mph) →	 A 32 cm (12 in)	 37-47-58 cm (15-19-23 in)	111 (245)

G 85d

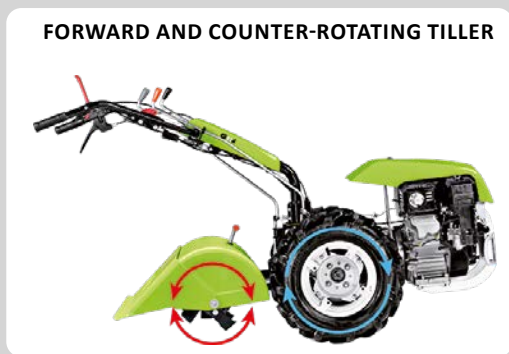

		HP-kW	CC	 L (US qts)		 DIFF. LOCK					 kg (lb)
G 85d	G 300 FA Loncin	HP 9.3 - kW 6.8	302/1	6,1 (6.4)		✓	4.00-10	4.00-10	A 32 cm (12 in)	37-47-58-68- 77 cm (15-19-23-27- 30 in)	127 (280)
	GX 270 Honda	HP 8.4 - kW 6.3	270/1	5,3 (5.6)		✓	1,3 km/h (0.8 mph)	1,3 km/h (0.8 mph)			127 (280)
	R 300 D Rato	HP 8.2 - kW 6	301/1	5,4 (5.7)		✓	3,0 km/h (1.9 mph)	3,0 km/h (1.9 mph)			142 (313)
	KD15 350 Kohler	HP 7.5 - kW 5.5	349/1	Diesel 4,3 (4.5)		✓	1,3 km/h (0.8 mph)	1,3 km/h (0.8 mph)			151 (332)

G 107d



		HP-kW	CC	 L (US qts)		 DIFF. LOCK					 kg (lb)
G 107d	G 300 FA Loncin	HP 9.3 - kW 6.8	302/1	 6,1 (6.4)		✓	 5.00-10	 5.00-10			136 (300)
	GX 270 Honda	HP 8.4 - kW 6.3	270/1	 5,3 (5.6)		✓	 1,3 km/h (0.8 mph) 2,4 km/h (1.5 mph) 3,6 km/h (2.2 mph)	 1,3 km/h (0.8 mph) 2,4 km/h (1.5 mph) 3,6 km/h (2.2 mph)	A 32 cm (12 in)	37-47-58-68- 77 cm (15-19-23-27- 30 in)	136 (300)
	R 300 D Rato	HP 8.2 - kW 6	301/1	 5,4 (5.7)		✓	 1,3 km/h (0.8 mph) 2,4 km/h (1.5 mph) 3,6 km/h (2.2 mph)	 1,3 km/h (0.8 mph) 2,4 km/h (1.5 mph) 3,6 km/h (2.2 mph)			150 (330)
	KD15 440 Kohler	HP 11 - kW 8.1	441/1	Diesel 5 (5.3)		✓	 1,3 km/h (0.8 mph) 2,4 km/h (1.5 mph) 3,6 km/h (2.2 mph)	 1,3 km/h (0.8 mph) 2,4 km/h (1.5 mph) 3,6 km/h (2.2 mph)			168 (370)

G 108 - G 110





































G 108



G 110



		 CC/HP HP-kW	 DIESEL L (US qts)		 Steering Brakes	 DIFF. LOCK					 kg (lb)
G 108	GX 270 Honda	270 cc/1 HP 8.4 - kW 6.3	 5,3 (5.6)		✓	✓	 5.00-10	 5.00-10			136 (300)
	GX 390 Honda	389 cc/1 HP 11.7 - kW 8.7	 6,1 (6.4)		✓	✓	 1,3 km/h (0.8 mph)  2,4 km/h (1.5 mph)  4,3 km/h (2.7 mph)	 1,3 km/h (0.8 mph)  2,4 km/h (1.5 mph)  4,3 km/h (2.7 mph)			144 (317)
G 110	KD15 440 Kohler	441 cc/1 HP 11 - kW 8.1	Diesel  5 (5.3)		✓	✓	 0,7 km/h (0.4 mph)  1,5 km/h (0.9 mph)  3,2 km/h (2.0 mph)	 0,7 km/h (0.4 mph)  1,5 km/h (0.9 mph)  3,2 km/h (2.0 mph)	 A 32 cm (12.6 in)	37-47-58-68- 77 cm (15-19-23-27- 30 in)	168 (370)
											

G 131 - G 131 BC



G 131



G 131 BC



G 131 BC



G 131 BC



G 131 BC

		HP-kW	CC/l								
				L (US qts)		DIFF. LOCK				kg (lb)	
G 131	KD15 440 Kohler	HP11 - kW8.1	441 cc/1	Diesel 5 (5.3)		✓	 5.00-12 I 1,2 km/h (0.7 mph) II 2,4 km/h (1.5 mph) III 3,4 km/h (2.1 mph) IV 7,1 km/h (4.4 mph)	 5.00-12 I 1,7 km/h (1.0 mph) II 3,5 km/h (2.2 mph) →	A 32 cm (12.6 in)	55-70-85 cm (22-28-34 in)	192 (423)
G 131 BC	Vanguard 16 B&S	HP 14 (16*) kW10.3	479/2	8,5 (8.9)		✓	 5.00-12 I 1,2 km/h (1.0 mph) II 3,5 km/h (2.2 mph) ←	 5.00-12 I 1,2 km/h (0.7 mph) II 2,4 km/h (1.49 mph) ←	A 32 cm (12.6 in)	55-70-85 cm (22-28-34 in)	195 (430)

* Gross Power

DUMPER

507- 406





















DUMPER 406



DUMPER 507









									
Dumper 406	G 200 FA Loncin	HP 5.5 - kW 4.1	196/1	 3 (3.2)		I 1,0 km/h (0.6 mph) II 2,0 km/h (1.2 mph)	I 1,0 km/h (0.6 mph) II 2,0 km/h (1.2 mph)	400 kg (882 lb)	270 (595)
	GX 200 Honda	HP 5.5 - kW 4.1	196/1	 3,1 (3.3)		III 3,5 km/h (2.2 mph)	III 3,5 km/h (2.2 mph)		268 (591)
Dumper 507	GX 270 Honda	HP 8.4 - kW 6.3	270/1	 5,3 (5.6)		I 1,0 km/h (0.6 mph) II 2,0 km/h (1.2 mph)	I 1,0 km/h (0.6 mph) II 2,0 km/h (1.2 mph)	500 kg (1102 lb)	302 (666)
	R 300 D Rato	HP 8.2 - kW 6	301/1	 5,4 (5.7)		III 3,5 km/h (2.2 mph)	II 2,0 km/h (1.2 mph) III 3,5 km/h (2.2 mph)		319 (703)
	KD15 350 Kohler	HP 7.5 - kW 5.5	349/1	 Diesel 4,3 (4.5)		IV 8,7 km/h (5.4 mph)	III 3,5 km/h (2.2 mph)		337 (743)

HWT 570











MULTIFORCE



										
	HP-kW	CC/1	L (US qts)						kg (lb)	
HWT 570 Multiforce	GCV 170 Honda	HP 4.8 - kW 3.6	166/1	0,9 (0.95)		--	41 cm (16.2 in)	15-30-50-60 mm (0.6-1.2-2-2.4 in)	60 cm (24 in)	48 (105.8)

HWT 600 WD













										
		HP-kW	CC	L (US qts)					kg (lb)	
HWT 600 WD	GCV 170 Honda	HP4.8 - kW3.6	166/1	0,9 (0.95)		2,5 km/h (1.5 mph)	41 cm (16.2 in)	15-30-50-60 mm (0.6-1.2-2-2.4 in)	60 cm (24 in)	47 (104)

HWT 700









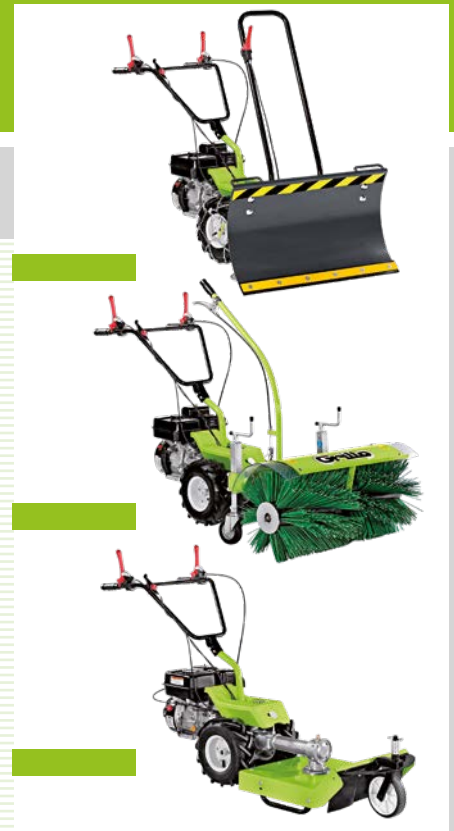

SUPERTRAC



											
		HP-kW	CC	L (US qts)						kg (lb)	
HWT 700 SUPERTRAC	FJ180V KAI Kawasaki	HP4.5 - kW3.4	179/1	1,7 (1.5)		2,5 km/h (1.5 mph)	3.50-8	38 cm (14.9 in)	15-30-50-60 mm (0.6-1.2-2-2.4 in)	60 cm (24 in)	62 (137)

GF 1



										
GF 1	G 200 FA Loncin	HP 5.5 - kW 4.1	196/1	3 (3.2) L (US qts)		13x5.00-6	2,20 km/h (1.4 mph)	-	86-96cm (34-38 in)	70 (154) kg (lb)

GF 2































		HP-kW		 L (US qts)						 kg (lb)
GF 2	G 200 FA Loncin	HP 5.5 - kW 4.1	196/1				 4.00-8	 4.00-8	110-117 cm (43-46 in)	98 (216)
	GX 200 Honda	HP 5.5 - kW 4.1	196/1				 1,0 km/h (0.6 mph)  2,0 km/h (1.2 mph)  3,0 km/h (1.9 mph)	 1,0 km/h (0.6 mph)  2,0 km/h (1.2 mph)  3,0 km/h (1.9 mph)		96 (212)

GF 3 - GF 3DF













GF 3DF



		HP-kW		 L (US qts)							
GF 3	G 300 FA Loncin	HP 9.3 - kW 6.8	302/1	6,1 (6.4)		-	-	 4.00-8	 4.00-8		105 (231)
	GX 270 Honda	HP 8.4 - kW 6.3	270/1	5,3 (5.6)		-	-	 1,0 km/h (0.6 mph)	 1,0 km/h (0.6 mph)	110-117 127-132-137 cm (43-46-50-52- 54 in)	103 (227)
	SH178 FA Norwik	HP 5.3 - kW 4	306/1	3,5 (3.6)				 1,0 km/h (0.6 mph)	 1,0 km/h (0.6 mph)		115 (254)
G 300 FA Loncin	HP 9.3 - kW 6.8	302/1	6,1 (6.4)				 2,0 km/h (1.2 mph)	 2,0 km/h (1.2 mph)	123 (271)		
GF 3DF	G 300 FA Loncin	HP 9.3 - kW 6.8	302/1	6,1 (6.4)		✓	✓	 2,0 km/h (1.2 mph)	 2,0 km/h (1.2 mph)		112 (245)
	GX 270 Honda	HP 8.4 - kW 6.3	270/1	5,3 (5.6)				 3,0 km/h (1.9 mph)	 3,0 km/h (1.9 mph)		110 (243)
	SH178 FA Norwik	HP 5.3 - kW 4	306/1	3,5 (3.6)							122 (269)
											130 (286)

GH 8 AGM



										
		HP-kW	CC	L (US qts)		HYDROSTATIC				kg (lb)
GH 8 AGM	G 210 FA Loncin	HP 6-kW 4.4	212/1	3,6 (3.8)		0 - 6 km/h (0 - 3.7 mph)	0 - 3 km/h (0 - 1.9 mph)	20...110 mm (0.78..4,3 in)	58 cm (22.8 in)	135 (297)











GH 9 AGM



GH 9 AGM	GX 270 Honda	HP 8.4 - kW 6.3	270/1	5,3 (5.6)		HYDROSTATIC		0 - 6 km/h (0 - 3.7 mph)	0 - 3 km/h (0 - 1.9 mph)	30...110 mm (1.2...4.3 in)	68 cm (26.8 in)	158 (348)









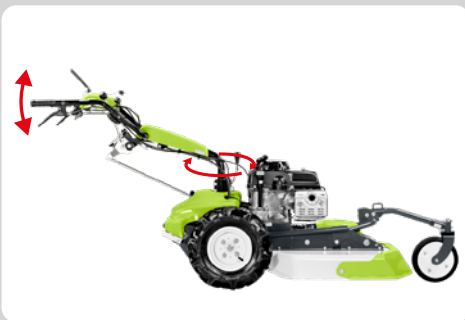

CL 62M



										
		HP-kW	CC	L (US qts)		HYDROSTATIC				kg (lb)
CL 62M	FJ180V Kawasaki	HP 4.5 - kW 3.4	179/1	1,6 (1.5)		0 - 4,7 km/h (0 - 2.9 mph)	0 - 3 km/h (0 - 1.9 mph)	50...110 mm (2.0...4.3 in)	62 cm (24.4 in)	98 (216)

CL 75



		HP-kW	 CC	 L (US qts)		 DIFF. LOCK					 kg (lb)		
CL 75	GXV 390 Honda	HP 10.2 - kW 7.6	389/1	2,1 (2.2)		✓	HYDROSTATIC		0 - 6 km/h (0 - 3.7 mph)	0 - 3,5 km/h (0 - 2.2 mph)	50...150 mm (2.0...5.9 in)	75 cm (29.5 in)	140 (309)

CLIMBER 7

7.15 - 7.18



CLIMBER 7.18





















CLIMBER 7.18



CLIMBER 7.15



		HP-kW		 L (US qts)	 DIFF. LOCK					 kg (lb)
7.15	LC1P92F Loncin	HP 12 (*15) kW 9.2	452/1	 7 (7.4)		HYDROSTATIC 0 - 9 km/h (0 - 5.6 mph)	 40 cm (15.7 in)	 35...85 mm (1.3...3.3 in)	 85 cm (33.5 in)	250 (551)
7.18	7160 EXi INTEK B&S	HP 15.2 (*18) kW 11.2	656/2	 7 (7.4)		HYDROSTATIC 0 - 9 km/h (0 - 5.6 mph)	 40 cm (15.7 in)	 35...85 mm (1.3...3.3 in)	 85 cm (33.5 in)	255 (562)

* Gross Power









CLIMBER 8

8.22



KIT MULCHING



		HP-kW		 L (US qts)	 DIFF. LOCK	 HYDROSTATIC			 kg (lb)	
8.22	7220 PXi PROFESSIONAL B&S	HP 18 (*22) kW 13.2	656/2	7 (7.4)	✓	0 - 10 km/h (0 - 6.2 mph)	60 cm (23.6 in)	35...110 mm (1.3...4.3 in)	91 cm (36 in)	290 (639)

CLIMBER 9

9.18 - 9.22s



CLIMBER 9.22s











CLIMBER 9.22s



CLIMBER 9.18



KIT MULCHING

		HP-kW		 L (US qts)						
9.18	7160 EXi INTEK B&S	HP15.2 (*18) kW11.2	656/2	13 (13.7)	✓	HYDROSTATIC 0 - 10 km/h (0 - 6.2 mph)	38 cm (15 in)	30...90 mm (1.2...3.5 in)	91 cm (36 in)	297 (655)
9.22s	7220 PXi PROFESSIONAL B&S	HP18 (*22) kW13.2	656/2	13 (13.7)	✓	HYDROSTATIC 0 - 10 km/h (0 - 6.2 mph)	38 cm (15 in)	30...90 mm (1.2...3.5 in)	91 cm (36 in)	310 (683)

* Gross Power

CLIMBER 10

AWD 27- AWD 23



CLIMBER 10 AWD 23



CLIMBER 10 AWD 27















AWD 27











AWD 23



		HP-kW		 L (US qts)	 DIFF. LOCK	 HYDROSTATIC				 kg (lb)
AWD 23	LC2P77F Loncin	HP22 kW 16	780/2	 13 (13.7)		0 - 9 km/h (0 - 5.6 mph)	76 cm (29.92 in)	35...135 mm (1.4...5.3 in)	93 cm (36.6 in)	350 (772)
AWD 27	8290 CXi COMMERCIAL B&S	HP 22 (*27) kW 16.2	724/2	 13 (13.7)		0 - 9 km/h (0 - 5.6 mph)	76 cm (29.92 in)	35...135 mm (1.4...5.3 in)	98 cm (38.6 in)	385 (849)

FK 700



		HP-kW		 L (US qts)	 DIFF. LOCK					 kg (lb)
FK 700	D 722 E4B Kubota	HP 18 kW 13.2	722/3	Diesel 31 (8.1)	✓	0 - 15 km/h (fast) 0 - 8 km/h (slow)	37 cm (14.5 in)	0...100 mm (0...3.9 in)	115 cm (45.2 in)	615 (1356)

MD 15-MD 18



MD 15



MD 15



MD 18



MD 18









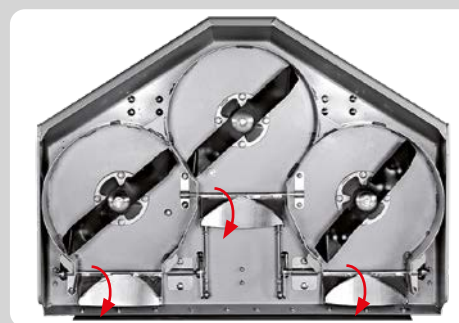

MD 18

		HP-kW								
			CC							
				L (US qts)	DIFF. LOCK					kg (lb)
MD 15	LC1P92F Loncin	HP 12 (*15) kW 9.2	452/1		--	HYDROSTATIC 0 - 9 km/h (0 - 5.6 mph)	40 cm (15.74 in)	25...80 mm (0.98...3.14 in)	QUICK SHIFT 83 cm (32.6 in)	235 (518)
MD 18	7160 EXI INTEK B&S	HP 15.2 (*18) kW 11.2	656/2		✓	HYDROSTATIC 0 - 9 km/h (0 - 5.6 mph)	40 cm (15.74 in)	25...80 mm (0.98...3.14 in)	QUICK SHIFT 83 cm (32.6 in)	270 (595.2)

MD 22N













		HP-kW		 L (US qts)	 DIFF. LOCK	 HYDROSTATIC	 60 cm (23.6 in)	 25...110 mm (0.9...4.3 in)	 QUICK SHIFT	 kg (lb)
MD 22N	7220 PXi PROFESSIONAL B&S	HP 18 (*22) kW 13.2	656/2	7 (7.4)	✓	0 - 10,5 km/h (0 - 6.5 mph)				315 (694)

* Gross Power

MD 24 AWD













										
MD 24 AWD	7220 PXi PROFESSIONAL B&S	HP 18 (*22) KW 13.2	656/2	13 (11.8)	✓	HYDROSTATIC 0-9 km/h (0 - 5.6 mph)	76 cm (29.92 in)	25...110 mm (0.9...4.3 in)	QUICK SHIFT 106 cm (41.7 in)	370 (816) kg (lb)

MD 28 AWD



MD 28 AWD













										
MD 28 AWD	8290 CXi COMMERCIAL B&S	HP 22 (*27) KW 16.2	724/2	13 (11.8)	✓	HYDROSTATIC 0-9 km/h (0 - 5.6 mph)	76 cm (29.92 in)	25...110 mm (0.9...4.3 in)	QUICK SHIFT 125 cm (49.2 in)	389 (856)

* Gross Power

FX 27

Zero-Turn













										
		HP-kW	CC	L (US Gal)					kg (lb)	H D W
FX 27	8290 CXi COMMERCIAL B&S	HP 22 (*27) kW 16.2	724/2	30 (7.9)	0 - 12 km/h (0 - 7.4 mph)	ZERO TURN	ELECTRIC 30...85 mm (1.2...3.3 in)	QUICK SHIFT 125 cm (49.2 in)	484 (1067)	H 170 cm D 132 cm W 258 cm

FD 220E













Full Electric



											
	MAX POWER	DECK POWER	TRACTION POWER	BATTERY CAPACITY						kg (lb)	H D W
FD 220E	11.7 kW	10 kW	1.7 kW	7.7 kWh	0 - 10 km/h (0 - 6.2 mph)	200 L 5.7 (US bu)	30 cm (11.8 in)	25...90 mm (1.0...3.5 in)	80 cm (31 in)	316 (696.6)	H 114 cm D 86 cm W 234 cm

FD 220R



		HP-kW		 L (US qts)						 kg (lb)	
FD 220R	LC1P92F Loncin	HP 12 (*15) kW 9.2	452/1	 7 (7.4)	HYDROSTATIC 0 - 9 km/h (0 - 5.6 mph)	200 L 5.7 (US bu)	30 cm (11.8 in)	30...90 mm (1.2...3.5 in)	80 cm (31 in)	263 (580)	H 114 cm D 86 cm W 234 cm
	VANGUARD 16 B&S	HP 14 (*16) kW 10.3	479/2	 7 (7.4)	HYDROSTATIC 0 - 9 km/h (0 - 5.6 mph)	200 L 5.7 (US bu)	30 cm (11.8 in)	30...90 mm (1.2...3.5 in)	80 cm (31 in)	270 (595)	

FD 280



		HP-kW									
FD 280	VANGUARD 16 B&S	HP 14 (*16) kW 10.3	479/2	8 (8.4)	✓	HYDROSTATIC	ELECTRIC	30 cm (11.8 in)	30...90 mm (1.2...3.5 in)	320 (705)	H 120 cm D 119 cm W 238 cm

* Gross Power













FD 450



		HP-kW		 L (US Gal)	 DIFF. LOCK	 HYDROSTATIC	 HYDRAULIC	 HYDRAULIC	 ELECTRIC		 kg (lb)	
FD 450	FS600V KAWASAKI	HP 17 kW 12.7.	603/2	 17 (4.5)	✓	0 - 9 km/h (0 - 5.59 mph)	450 L 12.8 (US bu)	30 cm (11.8 in)	25...90 mm (1.0...3.5 in)	113 cm (44 in)	460 (1014)	H ¹ 194 cm H 146 cm D 119 cm W 268 cm

FD 500









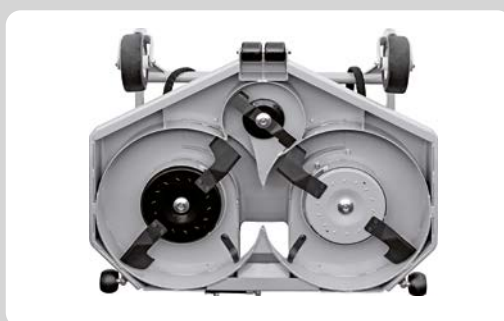



												
FD 500	D 722 E4B Kubota	HP 18 - kW 13.2	722/3	Diesel 22 (5.8)		0 - 13 km/h (0 - 8 mph)	700 L 19.8 (US bu)	32 cm (12.5 in)	ELECTRIC 25....90 mm (0.9...3.5 in)	113 cm (44.4 in)	610 (1345)	H ¹ 193 cm H 151 cm D 119 cm W 271 cm

FD 900

4WD













		HP-kW	CC	 L (US Gal)	 DIFF. LOCK						 kg (lb)	
FD 900 4WD	3TNV80F Yanmar	HP 25 - kW 18.4	1267/3	Diesel 31 (8.2)	✓	HYDROSTATIC 0 - 15 km/h (0 - 9 mph)	HYDRAULIC 750 L 21.3 (US bu)	HYDRAULIC 37 cm (14.6 in)	HYDRAULIC 20...100 mm (0.8...3.9 in)	126 cm (49.6 in)	980 (2160)	H ¹ 207 cm H 166 cm D 133 cm W 291 cm

FD 13.09

4WD













		HP-kW		 L (US Gal)	 DIFF. LOCK	 HYDROSTATIC	 HYDRAULIC	 HYDRAULIC	 HYDRAULIC	 HYDRAULIC	 kg (lb)	 H ¹ 213 cm H 175 cm D 141 cm W 325 cm
FD 13.09 4WD	3TNV82A Yanmar	HP 26 - kW 18.9	1331/3	Diesel 23 (6.0)	✓	0 - 15 km/h (0 - 9.3 mph)	900 L 25.5 (US bu)	31 cm (12 in)	20...100 mm (0.8...3.9 in)	132 cm (52 in)	1230 (2712)	H ¹ 213 cm H 175 cm D 141 cm W 325 cm
									20...120 mm (0.8...4.7 in)	152 cm (59.8 in)	1310 (2888)	H ¹ 213 cm H 175 cm D 162 cm W 340 cm

FD 2200

4WD



		HP-kW		 L (US Gal)	 DIFF. LOCK	 HYDROSTATIC	 HYDRAULIC	 HYDRAULIC			 kg (lb)	
FD 2200 4WD	3TNV88C Yanmar	HP 37 kW 27.5	1642/3	Diesel 50 (13.2)	✓	0 - 20 km/h (0 - 12.4 mph)	1200 L 34 (US bu)	62 cm (24 in)	25...110 mm (0.9...4.3 in)	152 cm (59.8 in)	1490 (3285)	H ¹ 243cm H 183 cm D 162 cm W 347 cm

FD 2200 TS

4WD













		HP-kW		 L (US Gal)	 DIFF. LOCK	 HYDROSTATIC	 HYDRAULIC	 HYDRAULIC	 HYDRAULIC	 HYDRAULIC	 kg (lb)	
FD 2200 TOP SCORER 4WD	4TNV88C Yanmar	HP 47 kW 34.3	2190/4	Diesel 50 (13.2)	✓	0 - 21 km/h (0 - 13.6 mph)	1400 L 39.7 (US bu)	60 cm (24 in)	20...120 mm (0.8...4.7 in)	152 cm (59.8 in)	1656 (3651)	H ¹ 231 cm H 199 cm D 162 cm W 364 cm
									182 cm (71.6 in)	1705 (3758)		H ¹ 231 cm H 199 cm D 194 cm W 369 cm

FM 13.09

4WD













		HP-kW		 L (US Gal)	 DIFF. LOCK	 HYDROSTATIC		 HYDRAULIC		 LMP	 kg (lb)	
FM 13.09 4WD	3TNV82A Yanmar	HP26-kW18.9	1331/3	Diesel 23 (6.0)	✓	0 - 15 km/h (0 - 9.3 mph)	12000 m ² /h	31 cm (12 in)	20...100 mm (0.8...3.9 in)	160 cm (63 in)	1150 (2535)	H ⁺ 213 cm H 175 cm D 192 cm W 299 cm

FM 2200

4WD



		HP-kW		 L (US Gal)								
FM 2200 4WD	3TNV88C Yanmar	HP 37 kW 27.5	1642/3	Diesel 50 (13.2)	✓	HYDROSTATIC 0 - 20 km/h (0 - 12.4 mph)	15500 m ² /h	HYDRAULIC 62 cm (24 in)	20...90 mm (0.8...3.5 in)	LMP 160 cm (63 in)	1322 (2915)	H ⁺ 243 cm H 183 cm D 192 cm W 347 cm



Nell'ottica di un costante sviluppo dei propri prodotti, Grillo Spa si riserva il diritto di cambiare le specifiche tecniche e le illustrazioni su questo documento in qualsiasi momento e senza preavviso ne obbligo. Foto e caratteristiche non contrattuali. In his pursuit of constant development of his products, Grillo Spa reserves the right to change the technical specifications and the illustrations on this document, at any given moment and without any kind of obligation. All the pictures characteristics are not contract-binding. En poursuivant une politique constante d'amélioration de ses produits, Grillo Spa se réserve le droit de modifier les spécifications techniques en tout temps sans préavis ni obligation. Photographies et caractéristiques non contractuelles. Aufgrund ständiger Weiterentwicklung behält sich Grillo Spa Änderungen in Form, Technik und Ausstattung der Produktpalette vor. Aus Angaben und Abbildungen des vorliegenden Grillo-Katalogs können daher keine Ansprüche abgeleitet werden. En vista de un desarrollo constante de sus productos, Grillo Spa se reserva el derecho de cambiar las especificaciones técnicas y las ilustraciones mostradas en este documento en cualquier momento y sin aviso previo. Las fotos y características no son contractuales.



Grillo
AGRIGARDEN
MACHINES

www.grillospa.it



grillo@grillospa.it
Tel. (+39) 0547.633111



 GrilloSpA



 Grillo SpA



 grillo.spA